



user manual



installation | operation | specifications | features | maintenance

www.ecoquest.com

(888) 664-1812





CONTENTS

Specifications	2
Introduction	2
Your New Fresh Air by Ecoguest	3
Inspection & Installation	3
Unit Features	3
Operation	4
Placement of Unit	4
Settings & Adjustments	5
LCD Display	5
Maintenance Reminders	6
General Maintenance	6
Removing the Rear Lint Screen	8
Removing the Purifier Plate & ActivePure (RCI) Cell	8
Installing the ActivePure (RCI) Cell & Purifier Plate	9
Installing the Rear Lint Screen	9
Troubleshooting	10

 **WARNING!** - Do not operate this unit without the rear lint screen AND back cover installed.

 **CAUTION!** - The Away Mode feature of this unit is to be operated in unoccupied areas only.

 **CAUTION!** - Disconnect power cord before servicing.

 **CAUTION!** - Do not operate unit near heat sources, open flame, or combustible vapors or gases.

 **CAUTION!** - Use extreme caution when using any appliance around children, the elderly, or people with disabilities and whenever the unit is operating unattended.

 **CAUTION!** - Keep unit out of reach of children.

INTRODUCTION

Congratulations, you have purchased one of the most effective, technologically advanced air purifiers available. Your new Fresh Air by Ecoguest is designed to provide years of trouble-free, low maintenance operation. Be sure to read and follow all service procedures outlined in this owner's manual, and use only genuine Ecoguest replacement parts available from your Ecoguest Business Owner.

If you have any questions concerning this, or any Ecoguest product, contact your Ecoguest Business Owner.

SPECIFICATIONS

Electrical:

- Input: 100-240VAC 50/60Hz 2.5A
- Output: 38V DC 2A
- 50 watts power consumption
- 24 to 30 KV, 20-30 Khz ion generation pulsator
- Fixed 6.5 KV DC needle ion generator

Size:

- Dimensions:
12" high x 9" wide x 12" deep
- Weight: 16 pounds

ActivePure (RCI) cell Output (Normal Mode):

- < 0.02 ppm ozone (ambient room concentration)

Purification Plate Output (High Mode):

- 0-360 mg of ozone per hour

Coverage:

- Covers a range of 250 ft² (23 m²) to 3000 ft² (279 m²)**

** Depends on variables such as severity and frequency of pollution, humidity, and temperature.

YOUR NEW FRESH AIR BY Ecoguest

- Eliminates smoke, odors, and tobacco smoke.
- Includes "Certified Space Technology" ActivePure (RCI) Technology, which incorporates the same process NASA uses to scrub the air inside spacecraft.
- Germicidal, broad spectrum, high-intensity UVX lamp (100 - 300 nm).
- Removes odors from your home, office, car, boat, RV, etc.
- Improves the quality of air indoors, up to 3000 ft² (279 m²).
- Customizable to your environment, using either the included remote or the controls on the front of the unit.
- IntelliAir Technology alerts you when normal maintenance needs to be performed or service is required.

INSPECTION & INSTALLATION

1. Remove protective packaging.
2. Remove unit from shipping carton.
3. Remove all protective materials.
4. Check for shipping damage and loose or broken parts.
5. Read Owner's Manual thoroughly prior to installation.
6. Install batteries in remote.
7. Determine placement location for the unit (See "Placement of Unit" on page 4). Plug the unit into a working electrical outlet.
8. Using either the remote control or the Power button, turn the unit ON.

UNIT FEATURES

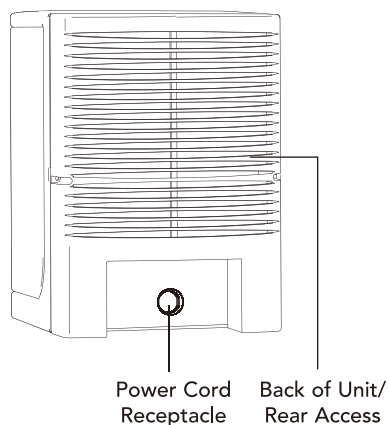
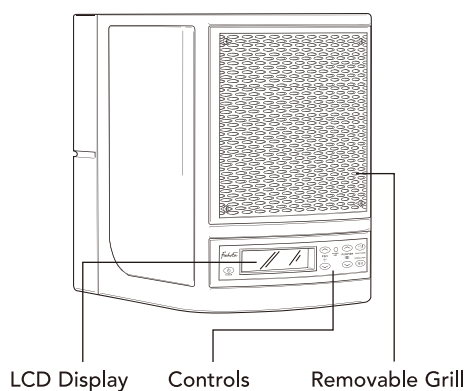

- Exclusive ActivePure (RCI) Technology
- Needlepoint and RF Ion Generation
- Five Speed Fan
- Adjustable Purifier Control (High Mode only)
- LCD Display
- Away Mode Function w/Adjustable Digital Timer
- IntelliAir Maintenance Reminders
- Remote Control or Manual Operation
- Computer Style Cord
- Uses Standard Household Current
- Washable Purification Plate
- Washable Rear Lint Screen
- Replaceable ActivePure (RCI) Cell
- Removable Front Grill

OPERATION

1. Adjust the fan speed to your preference, keeping in mind that higher fan speeds will give better results.
2. Using the *Normal/High* button, set the unit to NORMAL, for typical use, or HIGH, for increased smoke and odor control.
3. For HIGH MODE, using the PURIFIER UP and PURIFIER DOWN buttons, adjust the purification level to its lowest setting (250ft² (23 m²)) for the first 24 hours of operation, then gradually adjust up (if needed) to the square footage (or square meters) of the indoor area.

If you are operating your central heating and air conditioning fan, or other ventilation system, continuously, set the coverage up to the total ventilated indoor area. Otherwise, set the coverage up to the size of the room. Do not exceed the size of the ventilated indoor area when setting the purifier level.

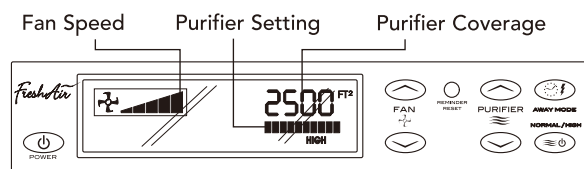

HIGH MODE: The unit's display shows the fan speed (low to high), the purifier setting (1 bar to 12 bars), and the purifier coverage in square feet, for U.S. models, and square meters, for international units.

4. To operate the AWAY MODE feature, in unoccupied areas only,* press the *Away Mode* button until the desired time is reached (2, 4, 6, or 8 hours). The unit will display AWAY MODE and the remaining time. To interrupt the AWAY MODE, press the *Normal/High* button.

**Please note: "unoccupied areas" includes pets. Some pets, like humans, may experience adverse reactions from exposure to increased levels of ozone and should not be present during AWAY MODE operation.*

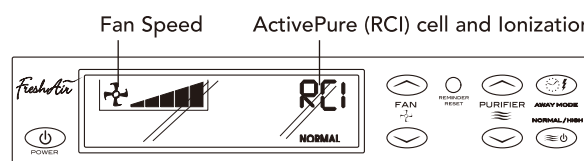

NORMAL MODE: The unit's display shows the fan speed (low to high) and NORMAL to indicate that the ActivePure (RCI) cell and ionization are both functioning normally.

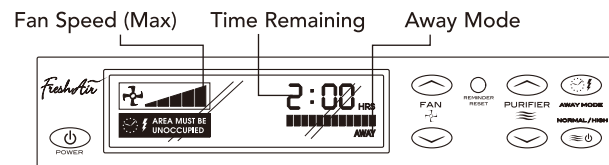

AWAY MODE: The fan will show maximum, and AWAY MODE will replace the purifier setting. The amount of time remaining will depend on how long you have selected for the AWAY MODE function to operate. The colon (:) will flash to indicate time being counted down.

PLACEMENT OF UNIT

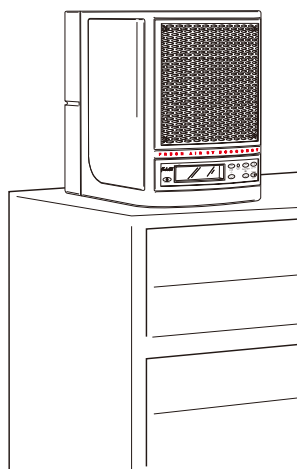

Place the unit as high as possible to insure complete purification. (On top of a bookshelf, high cabinet, etc.)

Suggested locations listed in the order of preference:

1. Nearest the source of the worst pollution.
2. Near a cold-air return to thoroughly circulate the benefits of your Fresh Air by Ecoguest throughout the area.
3. In the area most heavily used to achieve maximum benefit.

Note:

- The rear of the unit should always have at least one inch of open area to allow unrestricted airflow.
- Point the unit towards the center of the room for maximum dispersion of ions.
- To prevent injury, be sure the power cord is not accessible to small children.

SETTINGS AND ADJUSTMENTS

Fresh Air by Ecoguest can be turned on or off, and adjusted, using either the included remote or the control panel on the front of the unit. With the exception of the *Reminder Reset* button, both the remote and the control panel buttons have the same functions.

If you are operating your central heating and air conditioning fan, or other ventilation system, continuously, set the coverage up to the total ventilated indoor area. Otherwise, set the coverage up to the size of the room. Do not exceed the size of the ventilated indoor area when setting the purifier level.

POWER (stand by)

Turns the unit ON and OFF.

FAN UP/Fan DOWN

Adjusts the five speed fan.

Purifier Up/Purifier Down (high mode only)

Works when unit is in High Mode to set the purifier level for the indoor area. The level is indicated by both a horizontal bar graph and square footage (U.S. models) or square meters (international models). The unit will switch to Normal Mode, if the PURIFIER DOWN button is pressed when the square footage is set to 250 ft² (23 m²).

Sleep Mode

Turn on/off LCD backlight

NORMAL/HIGH

Toggles the unit between Normal Mode (ActivePure (RCI) and Ionization) and High Mode (ActivePure (RCI), Ionization, and Purification Plate).

Away mode

Turns on and adjusts the timer for the Away Mode function. Each press of the Away Mode button will increase the time by two hours, up to eight hours, then OFF. The AWAY MODE should be operated in unoccupied areas only.*

Reminder Reset

(control panel only)
Clears the maintenance reminders after performing routine maintenance.

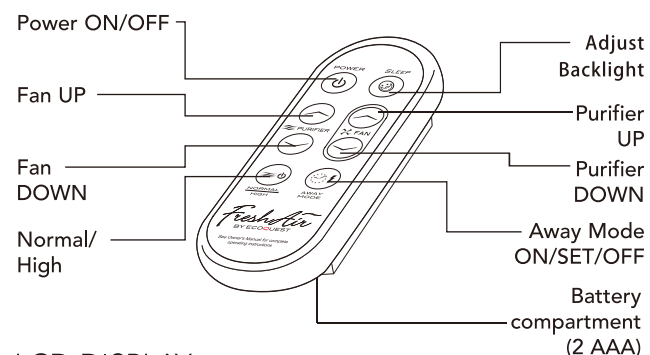
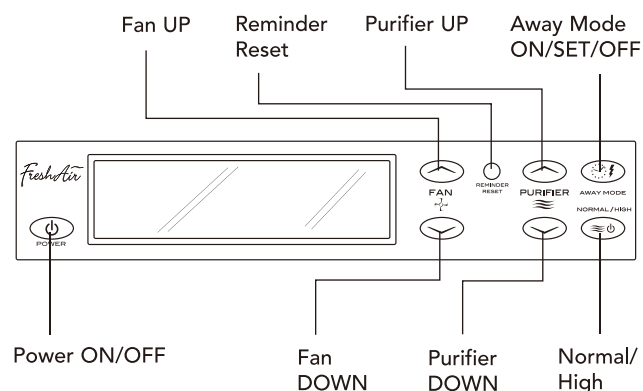

LCD DISPLAY

The LCD Screen is used to display all current settings (see page 4) as well as any maintenance reminders.

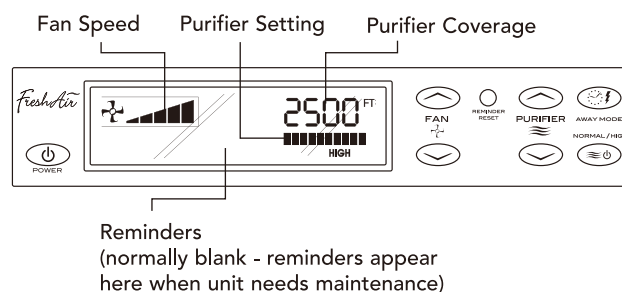

LCD SCREEN BACKLIGHT

As adjustments are being made, the LCD screen backlight will brighten and the settings on the screen will change. After 3 seconds, without change, the backlight will return to normal.

If a maintenance reminder or a service reminder appears, the backlight will brighten and stay bright until the Reminder Reset button is pressed or the service problem is corrected.

**Please note: "unoccupied areas" includes pets. Some pets, like humans, may experience adverse reactions from exposure to increased levels of ozone and should not be present during Away Mode operation.*

MAINTENANCE REMINDERS



REPLACE PLATE

The purifier plate is not functioning properly.

- Replace the old purifier plate with a new purifier plate (available from your local Ecoguest Business Owner).



REPLACE RCI CELL

The ActivePure (RCI) cell is no longer working correctly.

- Replace the ActivePure (RCI) cell (replacement cells are available from your local Ecoguest Business Owner).
- *Please Note: The ActivePure (RCI) cell should be replaced every two (2) years, even if the unit does not display this message.*



PERFORM CLEANING

(approx. every 30 days)

- Clean the rear lint screen (see page 6).
- Vacuum the ActivePure (RCI) cell.
- Clean the purifier plate (see page 7).
- Vacuum front and rear grill openings.

Be sure to press the Reminder Reset button to clear the reminder following regular maintenance (see below).

RESETTING THE REMINDERS

The only reminder you need to reset is the PERFORM CLEANING reminder (after performing maintenance, press the Reminder Reset button and the screen will momentarily display CLEARED to let you know the reminder has been cleared). All the other service reminders will clear automatically once the unit has been turned off and back on and the problem has been corrected.

GENERAL MAINTENANCE

Periodic maintenance is required to insure that your Fresh Air by Ecoguest operates properly. The unit will display a PERFORM CLEANING reminder when it's time to perform regular maintenance. If you are operating your unit in a severely polluted environment, cleaning of the unit, purifier plate, ActivePure (RCI) cell, and rear lint screen

GENERAL MAINTENANCE (CONT.)

should be done more frequently. Shown here are basic procedures that should be carried out to keep your unit running at top performance.

For optimal performance, and to prevent damage not covered by your warranty, install the optional Fresh Air purifier pre-filter.

Failure to perform routine maintenance could adversely affect the proper function of the unit or cause it to fail prematurely.

NOTE: If a unit is returned for repair, and it is determined that neglect of the unit or unauthorized tampering with any mechanical or electronic component of the unit caused the failure, Ecoguest reserves the right to void the product warranty. This will require the owner to pay for any required repairs.

CLEANING THE CASE:

Wipe the unit with a soft cloth dampened (not wet) with water. Do not use chemicals or solvents. Vacuum the front and rear grills periodically to remove any lint buildup.

CLEANING THE ACTIVEPURE (RCI) CELL:

Remove the ActivePure (RCI) cell and carefully vacuum accumulated lint. Do not wash the ActivePure (RCI) cell. Damage from water may result.

REAR LINT SCREEN CLEANING:

You have two options to clean the rear lint screen:

1. When visibly dirty, simply remove the rear lint screen from the unit (see pages 8 - 9), and with a hand-held vacuum, remove the heavy particulate. This method will extend the life of the lint screen.
2. When visibly dirty, remove the lint screen from the unit (see pages 8 - 9), carefully vacuum, then wash in hot water (do not use soap). Allow to dry prior to reinstalling. Replace if damaged.

REAR LINT SCREEN REPLACEMENT:

Contact your Ecoguest Business Owner for replacement lint screens. See pages 8 - 9 for removal and installation instructions.

CAUTION: Unplug the unit before performing any maintenance procedures.

GENERAL MAINTENANCE (CONT.)

CLEANING THE PURIFIER PLATE:

Remove the rear lint screen (see pages 8 - 9). Carefully remove the purifier plate from the card cage by grasping the middle of the edge nearest to you, and slowly pull it straight out.

If you are in an environment where there are fats, oils, or grease, such as in a kitchen, start by cleaning with denatured alcohol and a soft bristle brush. This will cut the grease without leaving a residue.

For all applications - Clean with a mixture of one part water and one part ammonia to remove contaminants. Place the plate into a shallow dish, and pour enough of the water/ammonia solution into the dish to just cover plate. Allow the plate to soak for no more than 10 minutes.

CAUTION: Damage may result from soaking the purifier plate longer than 10 minutes.

Remove plate and scrub with a soft bristle brush. Rinse thoroughly. Let air-dry for 24 hours or use a blow dryer to dry thoroughly.

The unit will display a REPLACE PLATE message if the purification plate needs to be replaced.

CHANGING THE ACTIVEPURE (RCI) CELL:

The ActivePure (RCI) cell should be changed when REPLACE RCI CELL appears on the display, or **every two (2) years**, whichever comes first. To change the ActivePure (RCI) cell, follow the instructions on pages 8 - 9.

OPTIONAL PREFILTER

To Remove:

Rear Back Panel follow steps 1 - 3, pg. 8

Prefilter follow steps 4 - 5 pg. 8

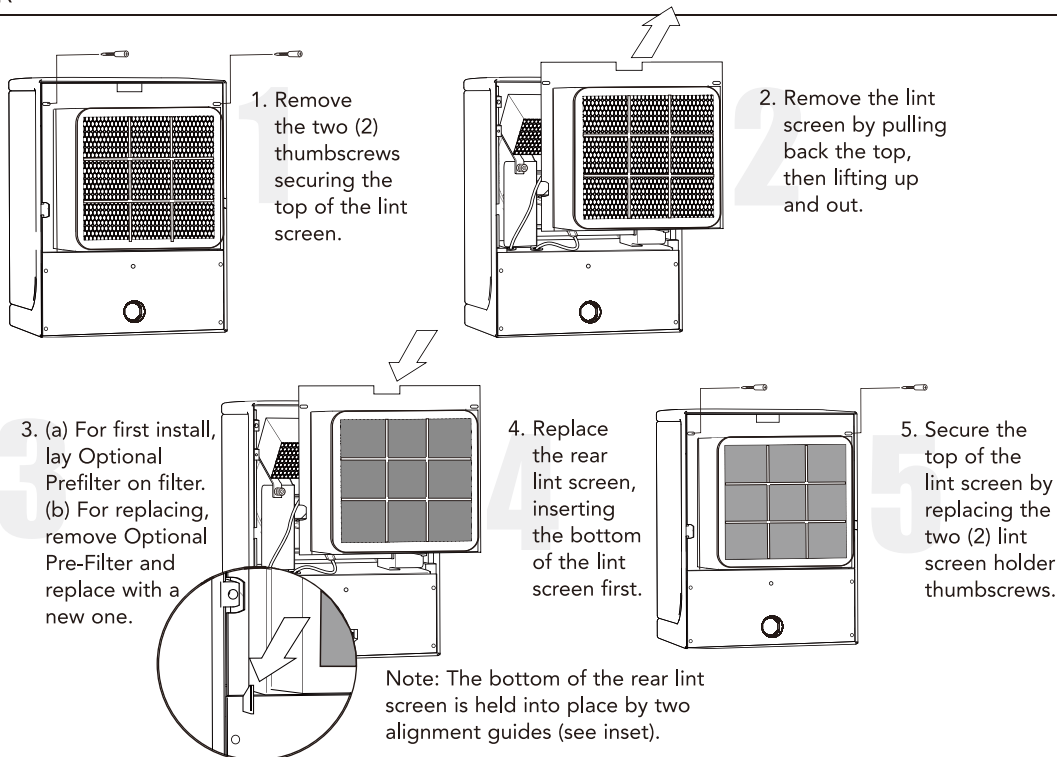

REMOVING THE REAR LINT SCREEN

To Remove:

Rear Lint Screen
follow steps 1 - 5

Purifier Plate
follow steps 1 - 6

ActivePure (RCI) cell
follow steps 1 - 10

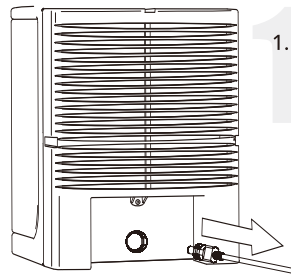

1. Unplug unit.

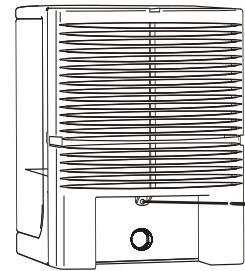

2. Remove the back cover screw.

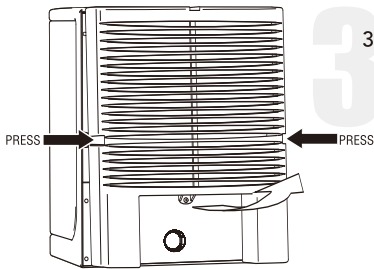

3. Remove back cover. Press the sides to unlatch, then tilt the bottom out to remove.

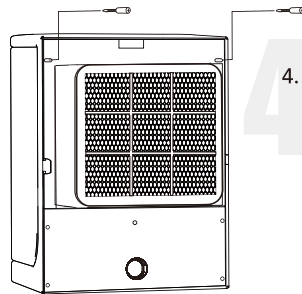

4. Remove two thumbscrews securing the top of the lint screen.

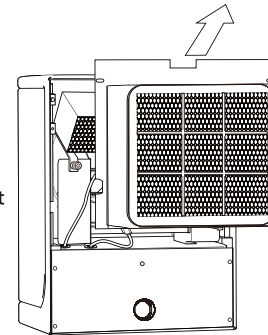

5. Remove the lint screen by pulling back the top, then lifting up and out.

REMOVING THE PURIFIER PLATE & ACTIVEPURE (RCI) CELL

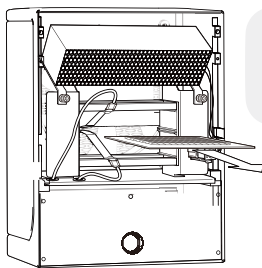

6. To remove the purification plate, grasp edge of plate in the center and gently pull out.

NOTE: If the plate is difficult to remove, gently press down on the lower metal contact tab.

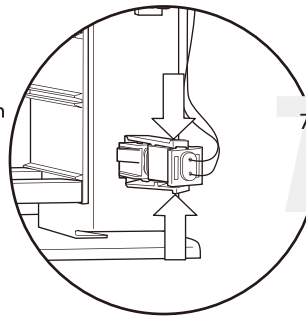

7. Unlock the ActivePure (RCI) cell connector by pressing on the connector's locking tabs.

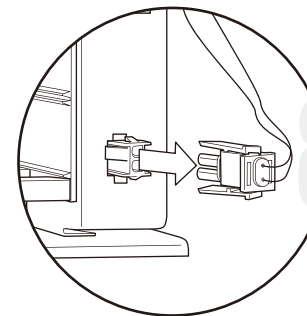

8. Pull the connector straight out to unplug.

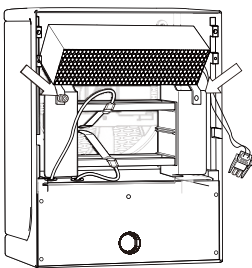

9. Remove two (2) thumbscrews.

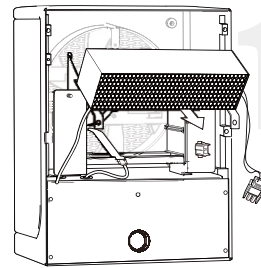

10. Slide the ActivePure (RCI) cell down and out of unit.

WARNING: Do not operate Fresh Air by Ecoquest without the rear lint screen and back cover properly installed.

INSTALLING THE ACTIVEPURE (RCI) CELL & PURIFIER PLATE

To Install:

Rear Lint Screen follow steps 5 - 9

Purifier Plate follow steps 4 - 9

ActivePure (RCI) cell follow steps 1 - 9

When installing the purification plate, be sure the metal tabs are making contact with the screen on each side of the plate.

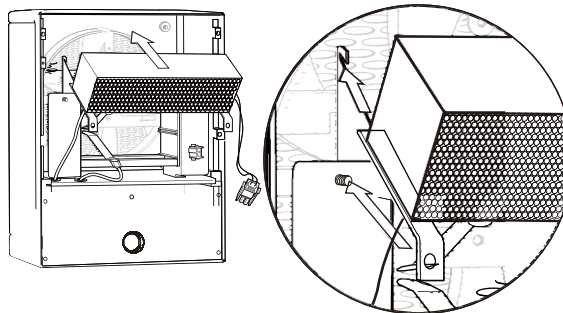

1. Slide the ActivePure (RCI) cell up and into the unit. Be sure the back lip of the ActivePure (RCI) cell engages the two slotted protrusions at the rear of the plate cage, and that the angle brackets and studs are correctly aligned.

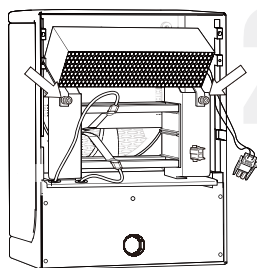

2. Replace the two (2) thumbscrews and tighten.

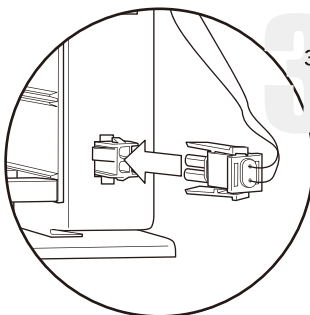

3. Insert the ActivePure (RCI) cell connector into the plug on the plate cage. Press the connector firmly until the two tabs lock into place.

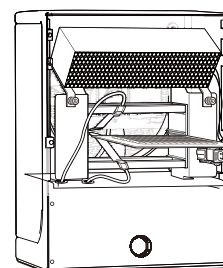

4. Gently insert the purifier plate between the guides (inside the cage) until it stops.

INSTALLING THE REAR LINT SCREEN

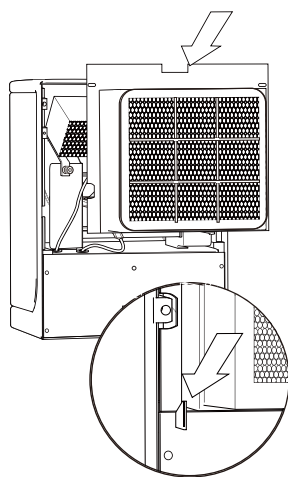

5. Replace the rear lint screen, inserting the bottom of the lint screen first.

Note: The bottom of the rear lint screen is held into place by two alignment guides (see inset).

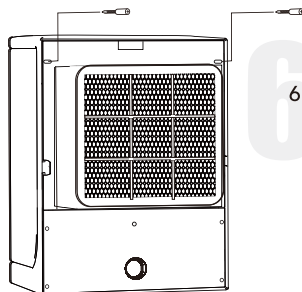

6. Secure the top of the lint screen by replacing the two (2) lint screen holder thumbscrews.

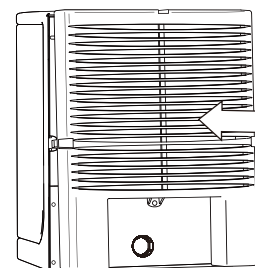

7. Replace the back cover by snapping into place.

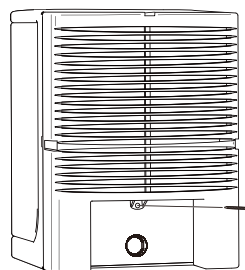

8. Replace the back cover screw.

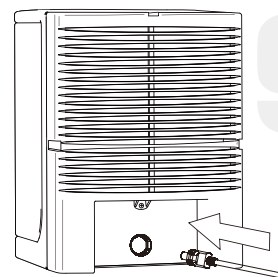

9. Reinstall the power cord.

WARNING: Do not operate Fresh Air by Ecoquest without the rear lint screen and back cover properly installed.

For disassembly instructions, see page 8.

TROUBLESHOOTING

INDICATORS OF OPERATION:

When the unit is on, the LCD display will show either the fan setting and NORMAL, or the fan setting, purifier setting, and square footage. If the unit is in Away Mode, it will display AWAY MODE plus the hours and minutes remaining. See page 4 for more information.

TROUBLESHOOTING - WHAT TO LOOK FOR FIRST.

1. *I have plugged in the unit, pressed the ON button on the remote (or the unit), and nothing happens... what's wrong?*

- Make sure the power cord is inserted completely into the receptacle on the back of the unit.
- Make sure the electrical outlet is capable of providing power to the unit.
- Check to see if the proper fuse is installed and that it is operational.

If you are operating your central heating and air conditioning fan, or other ventilation system continuously, set the coverage up to the total ventilated indoor area. Otherwise, set the coverage up to the size of the room. Do not exceed the size of the ventilated indoor area when setting the purifier level.

Please note: The AWAY MODE should be operated in unoccupied areas only. "Unoccupied areas" includes pets. Some pets, like humans, may experience adverse reactions from exposure to increased levels of ozone and should not be present during Away Mode operation.

2. *The fan is operating but the purifier plate is not working... what's wrong?*

- The unit is in Normal Mode (press the Normal/High switch to change to High Mode).
- If the unit is displaying a REPLACE PLATE message, check the purifier plate for serviceability. If it is cracked or broken, the purifier plate will require replacement. Ensure maintenance procedures required for the purifier plate have been performed according to the

"Maintenance" section of this Owner's Manual. Order new purifier plates from your Ecoguest Business Owner.

- The electrical stainless steel contacts are not contacting the screen portion of the purifier plate. Unplug and inspect the unit for any loose connections.
 - Do not attempt to disassemble the unit. This will void the warranty of the product.
3. *The purifier plate is making a noise, has a burning smell, and/or appears to arc or spark. What is the problem?*
- The purifier plate is most likely cracked. The unit will display a REPLACE PLATE message. Refer to the answers for question # 2, as it would apply to this question also.
4. *The UV lamp is not functioning/I'm getting a "Replace RCI Cell" message.*
- Check ActivePure (RCI) cell for proper installation.
 - Replace the ActivePure (RCI) cell.

CAUTION: *Do not look directly at the glowing lamp. Prolonged exposure, even to reflected UV light, can cause eye damage according to the American Conference of Governmental Industrial Hygienists (ACGIH) Standards. Fresh Air by Ecoguest emits UV light which can cause eye damage if the light were looked at continuously, for 20 minutes or more, at a distance of one (1) inch or less.*

5. *What are the most typical application problems?*

- Symptom: A belief that the proper equipment is placed in the environment and the equipment appears unsuccessful.
Problem: Lack of air movement, improper placement of the unit.
- Symptom: Strong odors still remain within the environment after placement.
Problem: Purifier setting is too low, improper placement of the unit, or the source of the odor has not been eliminated.
- Symptom: A strong odor of ozone is present within the environment.

TROUBLESHOOTING

Problem: Too much ozone accumulation, within the environment, as a result of improper purifier control setting, and/or lack of air movement.

- Symptom: Visual haze of smoke and/or particulate remain within the environment.

Problem: Lack of ionization and/or air movement.

6. *Air flow is restricted or reduced.*

- Is the unit properly placed away from objects that may obstruct air flow?
- Are the rear lint screen, back cover, and front grill clean?

- Is the ActivePure (RCI) cell clean?

7. *How can I tell if the ActivePure (RCI) cell is functioning?*

- The ActivePure (RCI) cell will produce a glow that is visible through the front grill under low light conditions.

8. *Unit does not operate.*

- Is the unit plugged in?
- Are you sure the outlet is active?
- Are the rear lint screen and back cover installed properly?
- Does the fuse need to be replaced?

